

The NEO8 and NEO8 PDR high performance wideband, planar-magnetic transducers

The NEO8 and Neo8 PDR are planar-magnetic (ribbon) transducers that use an innovative high-tech diaphragm material called Kaladex[®] from Dupont. This material, combined with a new proprietary technology for etching the aluminum/Kaladex[®] laminate, makes it possible to overcome the usual limitations of previous generation planar-magnetic designs. Traditionally most planar drivers were built using a Mylar[®] diaphragm but Kaladex[®] has a much higher thermal limit, lower mass, better durability and mechanical stability. As a result, the NEO8 and NEO8 PDR transducers have both higher sensitivity and power handling as well as excellent sound quality. The careful design and unique assembly technology employed by these units allow for more extended high frequency output, less distortion and higher dynamic range than with few other planar drivers of similar size.

The NEO8/NEO8PDR have a push-pull symmetrical magnet system that has been designed with the help of Finite Element Analysis software to achieve optimum efficiency/cost performance. It uses the newest grades of neodymium – the “super” magnet material with the highest magnetic energy. The extremely light Kaladex[®] diaphragm with an etched planar aluminum conductor is suspended in a magnetic field and is uniformly driven by the electromagnetic force providing accurate and immediate reproduction of the input signal. NEO8/NEO8PDR do not have heavy voice coils, spiders, glue joints, paper cones and surrounds, there is virtually nothing between the electrical signal and the sound - just an almost weightless diaphragm. Hence these planar transducers do not have cone break-up resonance with associated distortion, phase incoherency or signal smearing that is common for conventional drivers. This allows Neo drivers delivering clean, airy, transparent sound that is inherently natural and musically pleasing.

The purely resistive impedance of the NEO8/NEO8PDR makes an easy load for a power amplifier and greatly facilitates crossover design. The magnet system is completely shielded for safe implementation in multimedia and AV systems. The NEO8/NEO8PDR are very versatile transducers and their applications are limited only by the designer’s imagination.

Fig.1 shows a family of curves representing (from top to bottom) on-axis, 30° off-axis, and 60° off-axis response of the NEO8 measured as a dipole (without baffle or rear enclosure) at 1 metre for a 2.83V input. It is evident that the superior dispersion uniformity up to 7 kHz will allow the NEO8 to deliver smooth and balanced sound in a real listening environment. It is necessary to stress that using the NEO8 as a dipole (without any rear enclosure) may require some signal equalization at lower frequencies, since a dipole exhibits a natural roll-off. In some applications where flat on-axis response is desirable, the use of a correction network at 12 kHz is recommended; in others correction may not be necessary, since spatial averaging will provide smoother power response without the 12kHz peak reduction. Line array systems may not need the notch filter due to specifics of acoustical coupling in these systems. The notch filter schematic is given at the end of this document.

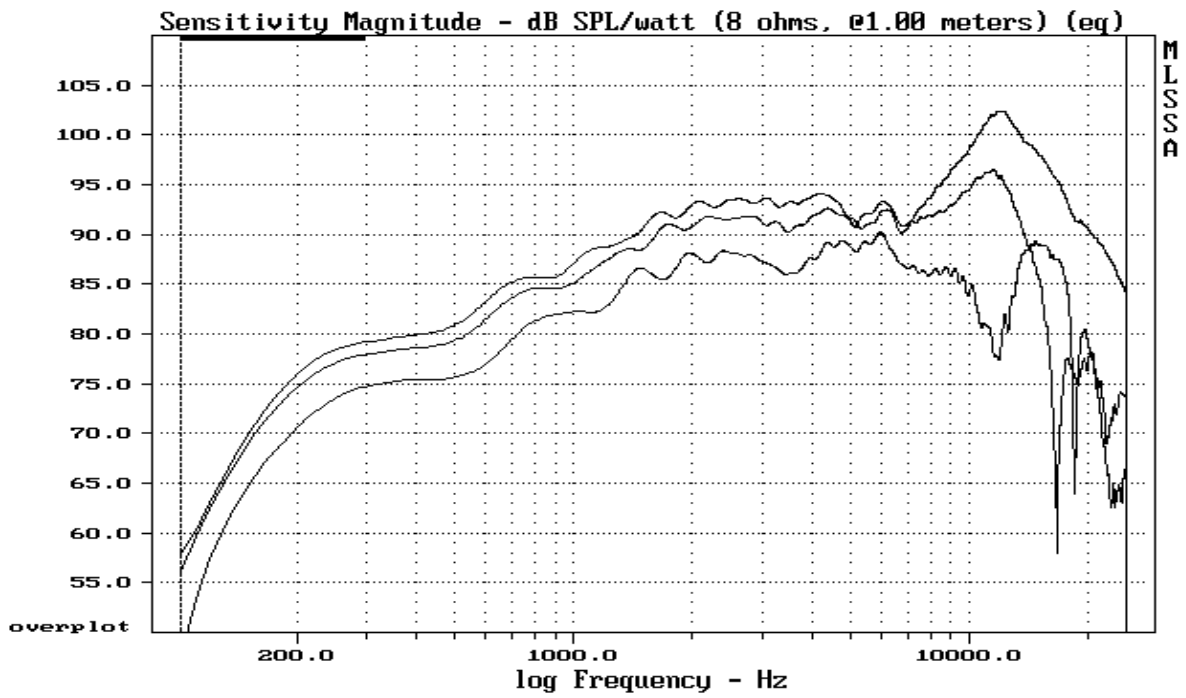

Fig.1 Neo 8 SPL on-axis, 30° off-axis, 60° of-axis.

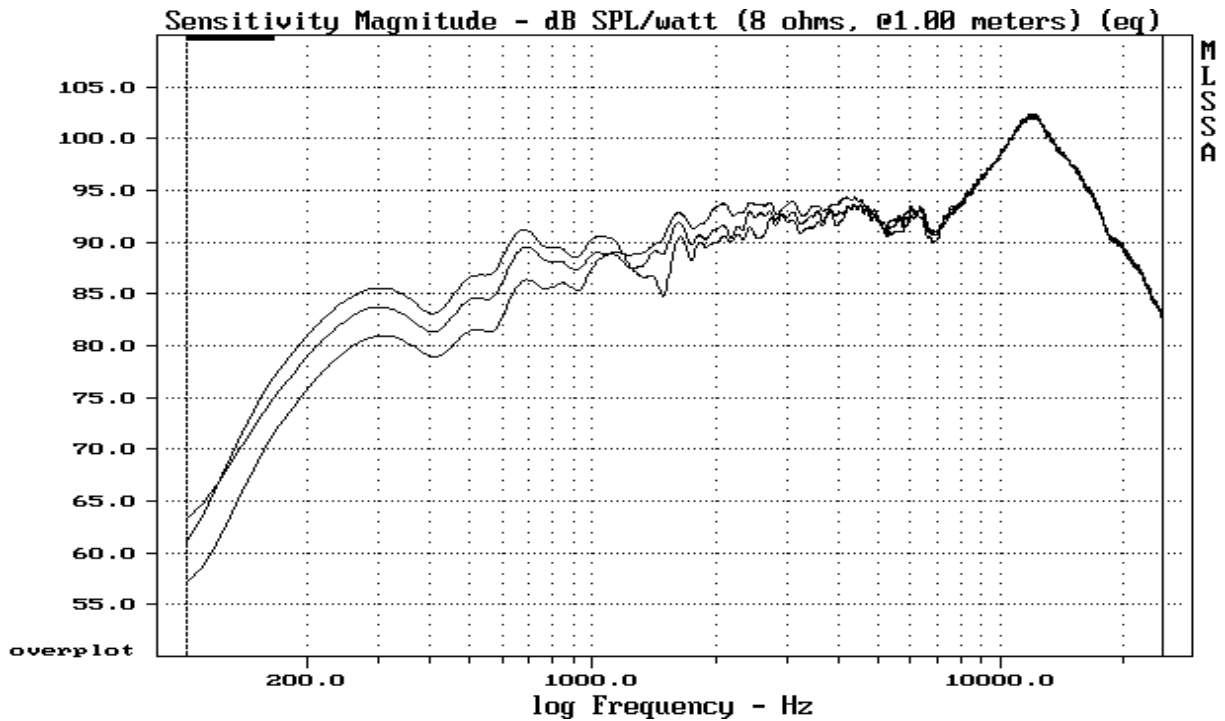

Fig.2 Neo 8 SPL, baffle loading effect.

Fig2. shows the effect of small baffle loading. This condition is close to a typical system or situation when the transducer is a part of matrix panel combining multiple drivers. Top curve – the NEO8 in the center of 9”x 9” baffle, middle curve - the NEO8 with 9”x 4.5” baffle from one

side, bottom curve – the NEO8 without a baffle. It is worthwhile to note that a carefully designed rear enclosure provides additional equalization at the low end of the reproduced frequency spectrum.

Fig.3 shows the Cumulative Decay Spectrum (CDS) plot of the NEO8. Even the best conventional transducers have decay times in the critical midrange region around 1.5 – 2ms (-20dB level drop) extending to 3-4 ms in lower frequencies. The NEO8 has a decay time of about 0.5ms across its entire effective range down to human voice fundamental frequencies. The absence of complex mechanical parts, common for a conventional driver, allows the NEO8 to perform free of delayed spectral contamination. This explains the NEO8’s unsurpassed clarity and the superb intelligibility of voice reproduction.

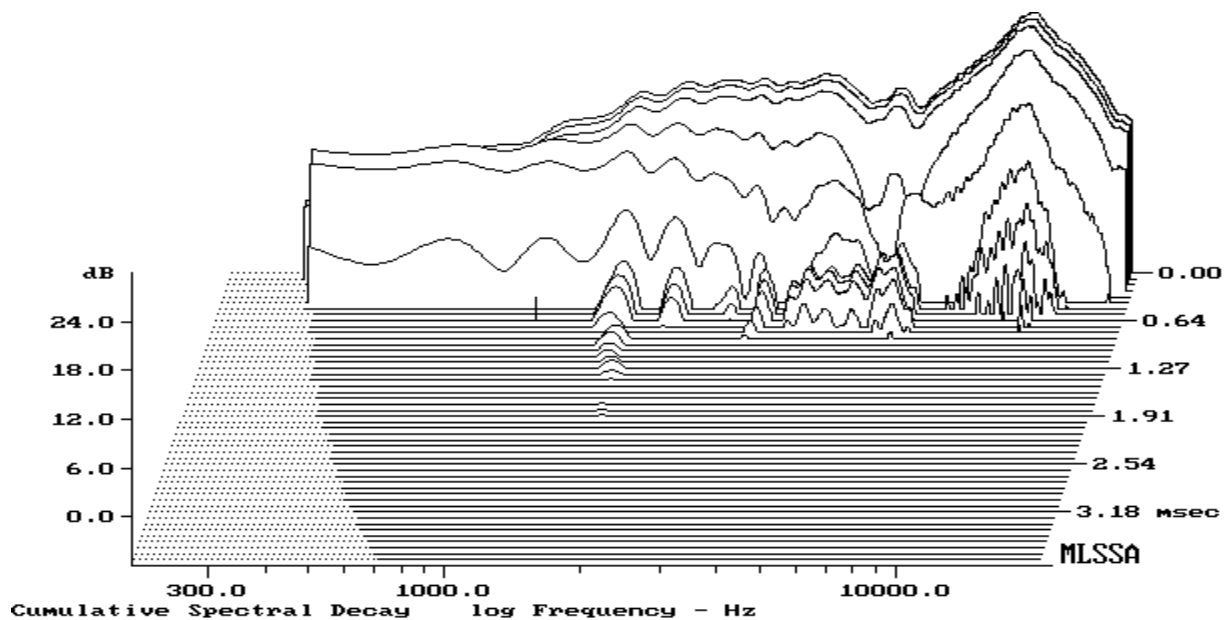

Fig.3 Neo 8 cumulative decay spectrum

The NEO8PDR is a modification of the Neo8 transducer. It incorporates patent pending PDR (progressive drive and radiation) technology allowing for a significantly wider horizontal dispersion above 8 kHz. The PDR technology provides progressively increasing excitation force from the periphery to the center portion of the diaphragm, while creating frequency dependant acoustic dampening and absorption across the diaphragm. This results in retaining of the efficiency in the effective range while dramatically widening high frequency dispersion. The Neo8PDR has slightly lower sensitivity below 500Hz and above 2 kHz (see Fig.4). However if an application does not require operation extended below 400-500 Hz, but instead calls for a wider horizontal coverage at high frequencies, than Neo8 PDR may be a better choice.

Fig.5 shows a family of on and off-axis frequency response curves of the Neo8 PDR, each one scaled down by -5 dB relatively to the previous curve.

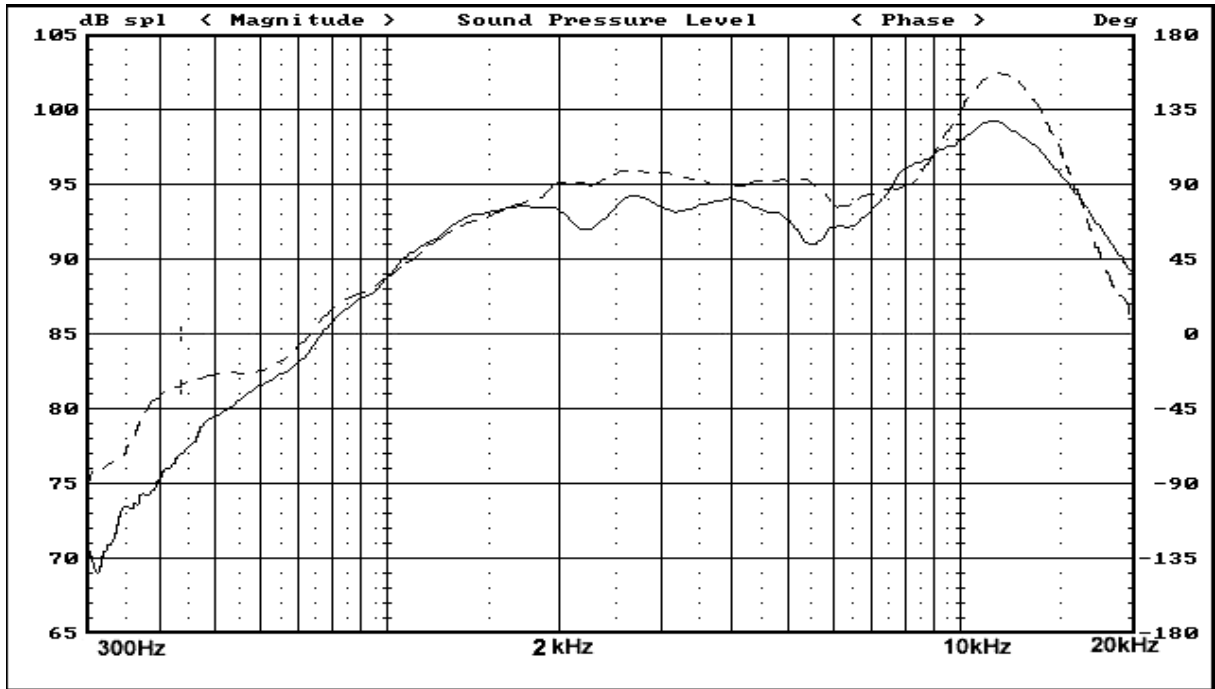

Fig.4 Neo 8/Neo 8PDR frequency response comparison, 2.83V/1m, no baffle, dipole operation. Neo8 – dash, Neo8 PDR – solid.

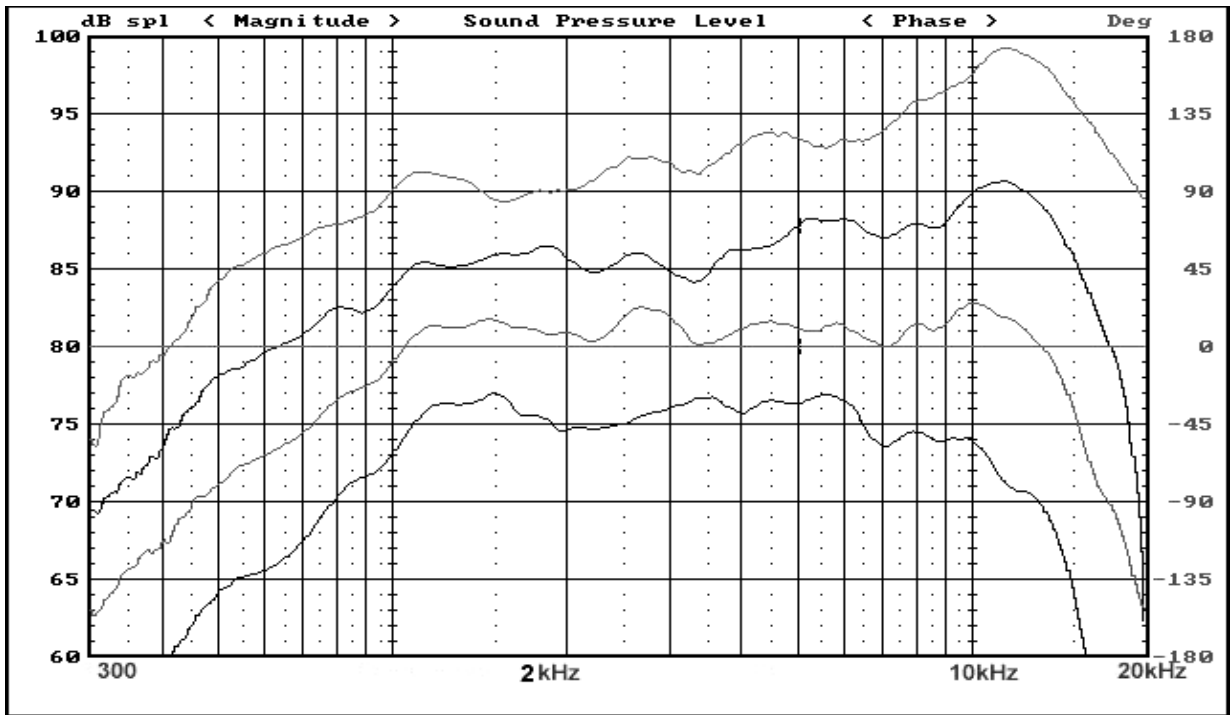
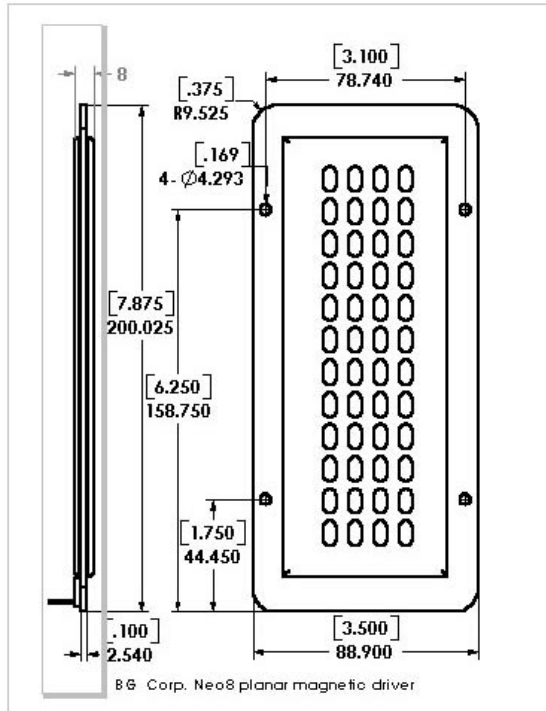

Fig.5 Neo 8PDR frequency response , 2.83V/1m, 12" baffle, dipole operation. From top to bottom: on axis, 30° off-axis (scaled -5dB), 45° off-axis (scaled -10dB), 60° off-axis (scaled -15dB).

Specifications

		NEO 8	NEO 8 PDR
1	Effective frequency range (with EQ at LF)	200 Hz-20 kHz	350Hz – 20 kHz
2	Recommended LF crossover, 2 nd order min, depends on a system max SPL requirements and acoustic arrangement of the transducers): <ul style="list-style-type: none"> - multimedia and mini systems - home theater and hi-fi, - line arrays 	220 Hz 500Hz-700 Hz 300 Hz -500 Hz	400 Hz 500 Hz-700 Hz 350 Hz -500 Hz
3	Horizontal dispersion (monopole, -6 dB): Below 2 kHz 4 kHz 8kHz 10 kHz 12.5kHz	180° 150 85° 70° 50°	180° 170° 120° 110° 85°
4	Sensitivity, 2.83V/1m, averaged in 1-8 kHz	94 dB	92.5 dB
5	Nominal impedance (3.6 Ω resistive over entire range)	4 ohm	4 ohm
6	Power handling: AES Program Peak	20 W 50 W 150W	17 W 40 W 120W
7	Weight	360 g	340 g



Recommended notch filter schematics

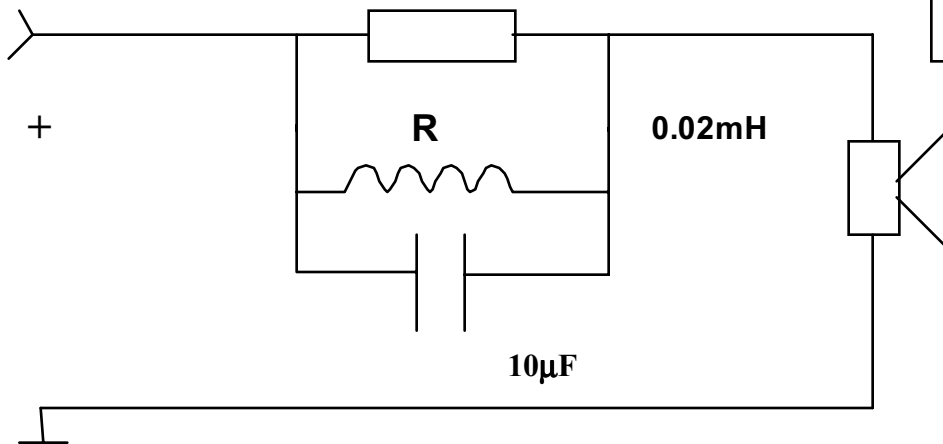

Recommended R value:
 Neo8 – 10 Ω
 Neo8 PDR - 3.3 Ω

Neo 8
 Neo 8 PDR

ATTENTION!

When connecting the Neo8/Neo8 PDR drivers, be careful not to overheat the terminals. This can lead to degradation of the diaphragm joint conductivity.